

**EUROTROL**®  
WATER TREATMENT COMPONENTS

# PRESSURE VESSELS AND ACCESSORIES

MWG, Structural



[Back to index](#)

---



## MWG Residential Pressure Vessels with Base



- Made in China;
- Composite pressure vessels PE liner reinforced with fiberglass and epoxy resin;
- For industrial and potable water treatment systems;
- European 2014/68/EU Directive compliant for pressure equipment (PED);
- Max operating pressure 10 bar; max operating temperature 50°C;
- Top connection threaded 2 1/2" - 8NPSM or 4"- 8UN; Cycle test 100.000 times from 0 to 10,5 bar;
- Burst test to 4 times max operating pressure;
- Blue colour;
- Warranty 10 years;
- **Note:** vacuum breaker and flexible connection mounting recommended.

Ref.	Description	Fam.	Subfam.	Disp. Stock	
BMWG05013BB	MWG PRESSURE VESSEL 5X13 2.5" BLUE	43	412	OK	
BMWG06013BB	MWG PRESSURE VESSEL 6X13 2.5" BLUE	43	412	OK	
BMWG06018BB	MWG PRESSURE VESSEL 6X18 2.5" BLUE	43	412	OK	
BMWG06035BB	MWG PRESSURE VESSEL 6X35 2.5" BLUE	43	412	OK	
BMWG07013BB	MWG PRESSURE VESSEL 7X13 2.5" BLUE	43	412	OK	
BMWG07017BB	MWG PRESSURE VESSEL 7X17 2.5" BLUE	43	412	OK	
BMWG07024BB	MWG PRESSURE VESSEL 7X24 2.5" BLUE	43	412	OK	
BMWG07030BB	MWG PRESSURE VESSEL 7X30 2.5" BLUE	43	412	OK	
BMWG07035BB	MWG PRESSURE VESSEL 7X35 2.5" BLUE	43	412	OK	
BMWG08013BB	MWG PRESSURE VESSEL 8X13 2.5" BLUE	43	412	OK	
BMWG08017BB	MWG PRESSURE VESSEL 8X17 2.5" BLUE	43	412	OK	
BMWG08024BB	MWG PRESSURE VESSEL 8X24 2.5" BLUE	43	412	OK	
BMWG08030BB	MWG PRESSURE VESSEL 8X30 2.5" BLUE	43	412	OK	
BMWG08035BB	MWG PRESSURE VESSEL 8X35 2.5" BLUE	43	412	OK	
BMWG08044BB	MWG PRESSURE VESSEL 8X44 2.5" BLUE	43	412	OK	
BMWG09017BB	MWG PRESSURE VESSEL 9X17 2.5" BLUE	43	412	OK	
BMWG09024BB	MWG PRESSURE VESSEL 9X24 2.5" BLU	43	412	OK	
BMWG09030BB	MWG PRESSURE VESSEL 9X30 2.5" BLUE	43	412	OK	
BMWG09035BB	MWG PRESSURE VESSEL 9X35 2.5" BLUE	43	412	OK	
BMWG09042BB	MWG PRESSURE VESSEL 9X42 2.5" BLUE	43	412	OK	
BMWG09048BB	MWG PRESSURE VESSEL 9X48 2.5" BLUE	43	412	OK	
BMWG10017BB	MWG PRESSURE VESSEL 10X17 2.5" BLUE	43	412	OK	
BMWG10019BB	MWG PRESSURE VESSEL 10X19 2.5" BLUE	43	412	OK	
BMWG10024BB	MWG PRESSURE VESSEL 10X24 2.5" BLUE	43	412	OK	
BMWG10030BB	MWG PRESSURE VESSEL 10X30 2.5" BLUE	43	412	OK	
BMWG10035BB	MWG PRESSURE VESSEL 10X35 2.5" BLUE	43	412	OK	
BMWG10044BB	MWG PRESSURE VESSEL 10X44 2.5" BLUE	43	412	OK	
BMWG10047BB	MWG PRESSURE VESSEL 10X47 2.5" BLUE	43	412	OK	
BMWG10054BB	MWG PRESSURE VESSEL 10X54 2.5" BLUE	43	412	OK	
BMWG10054GB	MWG PRESSURE VESSEL 10X54 4" BLUE	43	412	OK	
BMWG12048BB	MWG PRESSURE VESSEL 12X48 2.5" BLUE	43	412	OK	
BMWG12052BB	MWG PRESSURE VESSEL 12X52 2.5" BLUE	43	412	OK	
BMWG13044BB	MWG PRESSURE VESSEL 13X44 2.5" BLUE	43	412	OK	
BMWG13054BB	MWG PRESSURE VESSEL 13X54 2.5" BLUE	43	412	OK	
BMWG13054GB	MWG PRESSURE VESSEL 13X54 4" BLUE	43	412	OK	



## MWG Residential Pressure Vessels with Base

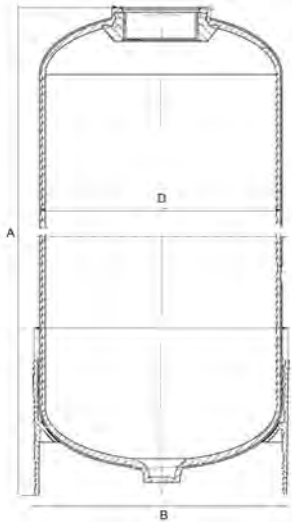

### Characteristics

Ref	Volume (Liters)	External D (mm)	A (mm)	B (mm)	Connection
BMWG05013BB	3,1	130	335 ± 6	135	2½
BMWG06013BB	4,7	155	335 ± 6	165	2½
BMWG06018BB	7,0	155	460 ± 6	165	2½
BMWG06035BB	14,8	155	892 ± 6	165	2½
BMWG07013BB	6,1	180	335 ± 6	188	2½
BMWG07017BB	8,4	180	435 ± 6	188	2½
BMWG07024BB	12,4	180	605 ± 6	188	2½
BMWG07030BB	16,1	180	770 ± 6	188	2½
BMWG07035BB	18,8	180	892 ± 6	188	2½
BMWG08013BB	7,8	207	332 ± 6	216	2½
BMWG08017BB	10,8	207	435 ± 6	216	2½
BMWG08024BB	16,4	207	620 ± 6	216	2½
BMWG08030BB	20,8	207	768 ± 6	216	2½
BMWG08035BB	24,5	207	892 ± 6	216	2½
BMWG08044BB	31,2	207	1125 ± 6	216	2½
BMWG09017BB	13,8	231	450 ± 6	240	2½
BMWG09024BB	20,5	231	617 ± 6	240	2½
BMWG09030BB	26,9	231	770 ± 6	240	2½
BMWG09035BB	32,1	231	895 ± 6	240	2½
BMWG09042BB	38,4	231	1070 ± 6	240	2½
BMWG09048BB	44,4	231	1221 ± 6	240	2½
BMWG10017BB	16,7	258	440 ± 6	266	2½
BMWG10019BB	19,3	258	479 ± 6	266	2½
BMWG10024BB	25,2	258	605 ± 6	266	2½
BMWG10030BB	33,0	258	775 ± 6	266	2½
BMWG10035BB	39,4	258	896 ± 6	266	2½
BMWG10044BB	51	258	1128 ± 6	266	2½
BMWG10047BB	54	258	1190 ± 6	266	2½
BMWG10054BB	63	258	1385 ± 6	266	2½
BMWG10054GB	63	258	1385 ± 6	266	4
BMWG12048BB	78	310	1234 ± 6	318	2½
BMWG12052BB	84,5	310	1334 ± 6	318	2½
BMWG13044BB	82	335	1118 ± 6	343	2½
BMWG13054BB	103	335	1375 ± 6	343	2½
BMWG13054GB	103	335	1375 ± 6	343	4

Certificates	Manufacturer	Sectors
DM174-2004, ACS, KTW CE, EAC	<b>MWG</b>	Domestic

## Spare Parts for MWG Pressure Vessels

### Bases for MWG Pressure Vessels

Ref.	Description	Fam.	Subfam.	Disp. Stock
BMWGS06	MWG STANDARD BASE 6"	43	196	OK
BMWGS07	MWG STANDARD BASE 7"	43	196	OK
BMWGS08	MWG STANDARD BASE 8"	43	196	OK
BMWGS09	MWG STANDARD BASE 9"	43	196	OK
BMWGS10	MWG STANDARD BASE 10"	43	196	OK



## Structural Residential Pressure Vessels with Base



- Made in European Union (Belgium);
- Composite pressure vessels PE liner reinforced with fiberglass and epoxy resin; For industrial and potable water treatment systems;
- Max operating pressure 10 bar;
- Max operating temperature 50°C;
- Top connection threaded 2 ½" – 8NPSM or 4"– 8UN;
- Cycle test 250.000 times from 0,7 to 10 bar;
- Burst test to 4 times max operating pressure;
- Blue colour;
- Warranty 5 years;
- **Note:** vacuum breaker and flexible connection mounting recommended.

Ref.	Description	Fam.	Subfam.	Disp. Stock
BSQ0618A3	STRUCTURAL PRESSURE VESSEL 6X18 2.5" BLUE	43	432	OK
BSQ0735A3	STRUCTURAL PRESSURE VESSEL 7X35 2.5" BLUE	43	432	OK
BSQ0817A3	STRUCTURAL PRESSURE VESSEL 8X17 2.5" BLUE	43	432	OK
BSQ0835A3	STRUCTURAL PRESSURE VESSEL 8X35 2.5" BLUE	43	432	
BSQ0935A3	STRUCTURAL PRESSURE VESSEL 9X35 2.5" BLUE	43	432	OK
BSQ1019A3	STRUCTURAL PRESSURE VESSEL 10X19 2.5" BLUE	43	432	NO
BSQ1035A3	STRUCTURAL PRESSURE VESSEL 10X35 2.5" BLUE	43	432	OK
BSQ1044P3	STRUCTURAL PRESSURE VESSEL 10X44 2.5" BLUE	43	432	OK
BSQ1054P3	STRUCTURAL PRESSURE VESSEL 10X54 2.5" BLUE	43	432	OK
BSQ1248P3	STRUCTURAL PRESSURE VESSEL 12X48 2.5" BLUE	43	432	OK
BSQ1252P3	STRUCTURAL PRESSURE VESSEL 12X52 2.5" BLUE	43	432	OK
BSQ1354A3	STRUCTURAL PRESSURE VESSEL 13X54 2.5" BLUE	43	432	OK

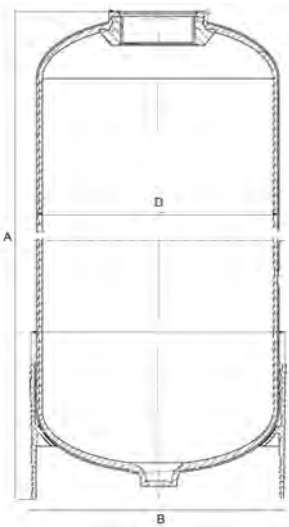

Ref	Volume (liters)	External D (mm)	A (mm)	B (mm)	Connection
BSQ0618A3	6,9	159	475 ± 2	170	2½
BSQ0735A3	20,4	184	901 ± 2	195	2½
BSQ0817A3	11,0	208	435 ± 2	220	2½
BSQ0835A3	25,7	208	902 ± 2	220	2½
BSQ0935A3	31,3	233	903 ± 2	240	2½
BSQ1019A3	19,1	257	502 ± 2	269	2½
BSQ1035A3	38,9	257	903 ± 2	269	2½
BSQ1044P3	48	257	1122 ± 2	269	2½
BSQ1054P3	61	257	1385 ± 2	269	2½
BSQ1248P3	76	304	1232 ± 3	315	2½
BSQ1252P3	84	304	1335 ± 3	315	2½
BSQ1354A3	103	334	1371 ± 3	330	2½

Certificates	Manufacturer	Sectors
DM174-2004, ACS, KTW, WRAS, CE, EAC	Pentair	Domestic



## MWG Residential Pressure Vessels without Base



- Made in China;
- Composite pressure vessels PE liner reinforced with fiberglass and epoxy resin;
- For industrial and potable water treatment systems;
- Max operating temperature 50°C;
- Top connection threaded 2 ½" - 8NPSM or 4"- 8UN;
- Cycle test 100.000 times from 0 to 10,5 bar;
- Burst test to 4 times max operating pressure;
- Blue colour;
- Warranty 10 years;
- **Note:** vacuum breaker and flexible connection mounting recommended.

Ref.	Description	Fam.	Subfam.	Disp. Stock	
BMWG05013AB	MWG PRESSURE VESSEL 5X13 2.5" NO BASE BLUE	43	410	OK	
BMWG05017AB	MWG PRESSURE VESSEL 5X17 2.5" NO BASE BLUE	43	410	OK	
BMWG05024AB	MWG PRESSURE VESSEL 5X24 2.5" NO BASE BLUE	43	410	OK	
BMWG06013AB	MWG PRESSURE VESSEL 6X13 2.5" NO BASE BLUE	43	410	OK	
BMWG06017AB	MWG PRESSUR VESSEL 6X17 2.5" NO BASE BLUE	43	410	OK	
BMWG06024AB	MWG PRESSURE VESSEL 6X24 2.5" NO BASE BLUE	43	410	OK	
BMWG07013AB	MWG PRESSURE VESSEL 7X13 2.5" NO BASE BLUE	43	410	OK	
BMWG07017AB	MWG PRESSURE VESSEL 7X17 2.5" NO BASE BLUE	43	410	OK	
BMWG07019AB	MWG PRESSURE VESSEL 7X19 2.5" NO BASE BLUE	43	410	OK	
BMWG07024AB	MWG PRESSURE VESSEL 7X24 2.5" NO BASE BLUE	43	410	OK	
BMWG07030AB	MWG PRESSURE VESSEL 7X30 2.5" NO BASE BLUE	43	410	OK	
BMWG07035AB	MWG PRESSURE VESSEL 7X35 2.5" NO BASE BLUE	43	410	OK	
BMWG08013AB	MWG PRESSURE VESSEL 8X13 2.5" NO BASE BLUE	43	410	OK	
BMWG08017AB	MWG PRESSURE VESSEL 8X17 2.5" NO BASE BLUE	43	410	OK	
BMWG08024AB	MWG PRESSURE VESSEL 8X24 2.5" NO BASE BLUE	43	410	OK	
BMWG08030AB	MWG PRESSURE VESSEL 8X30 2.5" NO BASE BLUE	43	410	OK	
BMWG08035AB	MWG PRESSURE VESSEL 8X35 2.5" NO BASE BLUE	43	410	OK	
BMWG09017AB	MWG PRESSURE VESSEL 9X17 2.5" NO BASE BLUE	43	410	OK	
BMWG09024AB	MWG PRESSURE VESSEL 9X24 2.5" NO BASE BLUE	43	410	OK	
BMWG09030AB	MWG PRESSURE VESSEL 9X30 2.5" NO BASE BLUE	43	410	OK	
BMWG09035AB	MWG PRESSURE VESSEL 9X35 2.5" NO BASE BLUE	43	410	OK	
BMWG10017AB	MWG PRESSURE VESSEL 10X17 2.5" NO BASE BLUE	43	410	OK	
BMWG10019AB	MWG PRESSURE VESSEL 10X19 2.5" NO BASE BLUE	43	410	OK	
BMWG10024AB	MWG PRESSURE VESSEL 10X24 2.5" NO BASE BLUE	43	410	OK	
BMWG10030AB	MWG PRESSURE VESSEL 10X30 2.5" NO BASE BLUE	43	410	OK	
BMWG10035AB	MWG PRESSURE VESSEL 10X35 2.5" NO BASE BLUE	43	410	OK	



## MWG Residential Pressure Vessels without Base

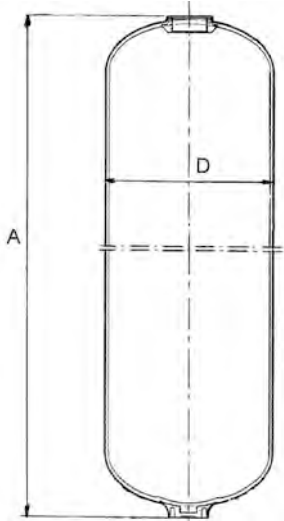

Ref	Volume (liters)	External D (mm)	A (mm)	Connection (inch)
BMWG05013AB	3,1	129	329 ± 3	2½
BMWG05017AB	4,3	129	431 ± 3	2½
BMWG05024AB	6,4	129	611 ± 3	2½
BMWG06013AB	4,7	159	329 ± 3	2½
BMWG06017AB	6,5	159	431 ± 3	2½
BMWG06024AB	9,8	159	611 ± 3	2½
BMWG07013AB	5,9	180	329 ± 3	2½
BMWG07017AB	8,2	180	431 ± 3	2½
BMWG07019AB	9,4	180	483 ± 3	2½
BMWG07024AB	12,4	180	611 ± 3	2½
BMWG07030AB	16,1	180	771 ± 3	2½
BMWG07035AB	18,9	180	891 ± 3	2½
BMWG08013AB	7,6	207	329 ± 3	2½
BMWG08017AB	10,7	207	431 ± 3	2½
BMWG08024AB	16,3	207	611 ± 3	2½
BMWG08030AB	21,2	207	771 ± 3	2½
BMWG08035AB	25,0	207	891 ± 3	2½
BMWG09017AB	13,3	230	431 ± 3	2½
BMWG09024AB	20,3	230	611 ± 3	2½
BMWG09030AB	26,5	230	771 ± 3	2½
BMWG09035AB	31,1	230	891 ± 3	2½
BMWG10017AB	16,4	257,5	431 ± 3	2½
BMWG10019AB	19,0	257,5	483 ± 3	2½
BMWG10024AB	25,2	257,5	611 ± 3	2½
BMWG10030AB	33,0	257,5	771 ± 3	2½
BMWG10035AB	38,8	257,5	891 ± 3	2½

Certificates	Manufacturer	Sectors
DM174-2004 ACS KTW CE, EAC	<b>MWG</b>	Domestic



## MWG Dome-Hole Residential Pressure Vessels



- Made in China;
- Composite pressure vessels PE lined reinforced with fiberglass and epoxy resin;
- 1 ¼" opening on the dome top of the tank with Noryl plug;
- For industrial and drinking water treatment systems;
- European 2014/68/EU Directive compliant for pressure equipment (PED);
- Max operating pressure 10 bar;
- Max operating temperature 50°C;
- Top connection threaded 2 ½" -8NPSM;
- Cycle test 100.000 times from 0 to 10,5 bar;
- Burst test to 4 times max operating pressure;
- Blue colour;
- 10 years warranty.

Ref.	Description	Fam.	Subfam.	Disp. Stock	
BMWG10044QB	MWG PRESSURE VESSEL 10X44 DOME HOLE 2.5" BLUE	43	415	OK	
BMWG10054QB	MWG PRESSURE VESSEL 10X54 DOME HOLE 2.5" BLUE	43	415	OK	
BMWG12052QB	MWG PRESSURE VESSEL 12X52 DOME HOLE 2.5" BLUE	43	415	OK	
BMWG13054QB	MWG PRESSURE VESSEL 13X54 DOME HOLE 2.5" BLUE	43	415	OK	

Ref.	Volume (liters)	D External (mm)	A (mm)	B (mm)	Connection (inches)
BMWG10044QB	51	258	1128	261	2½
BMWG10054QB	63	258	1388	261	2½
BMWG12052QB	84,5	306	1322	311	2½
BMWG13054QB	103	332	1369	336	2½

Ref.	Box: WxLxH	Box: Q.ty	Box: Weight	Pallet: WxLxH	Pallet: Q.ty	Pallet: Weight
BMWG10044QB						
BMWG10054QB						
BMWG12052QB						
BMWG13054QB						

Certificates	Manufacturer	Sectors
CE	<b>MWG</b>	Commercial, Industrial

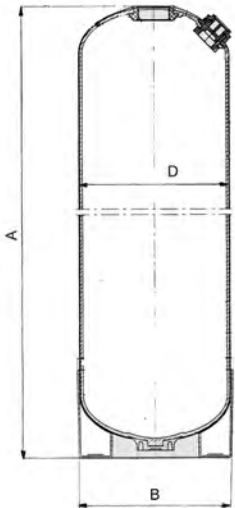





## MWG Industrial Pressure Vessels With Threaded Top Opening

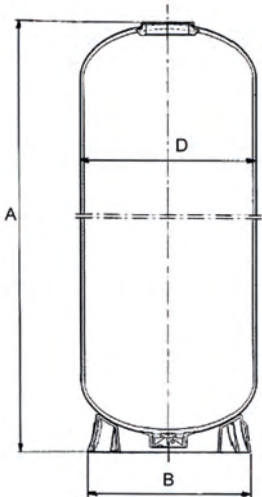

- Made in China; Composite pressure vessels PE liner reinforced with fiberglass and epoxy resin;
- For industrial and potable water treatment systems; Cycle test 100.000 times from 0 to 10,5 bar;
- European 2014/68/EU Directive compliant for pressure equipment (PED); Warranty 10 years;
- Max operating pressure 10 bar; Max operating temperature 50°C; Burst test to 4 times max operating pressure;
- Pressure vessels ≤ 16" are shipped with 2.5" reduction; Pressure vessels ≥ 30" are shipped with vacuum breaker;
- **Note:** vacuum breaker and flexible connection mounting are highly recommended.

Ref	Description	Fam.	Subfam.	Disp. Stock	
BMWG14052GB	MWG PRESSURE VESSEL 14X52 4" BLUE WITH ADAPTER 2.5"	44	420	OK	
BMWG14065GB	MWG PRESSURE VESSEL 14X65 4" BLUE WITH ADAPTER 2.5"	44	420	OK	
BMWG16052GB	MWG PRESSURE VESSEL 16X52 4" BLUE WITH ADAPTER 2.5"	44	420	OK	
BMWG16065GB	MWG PRESSURE VESSEL 16X65 4" BLUE WITH ADAPTER 2.5"	44	420	OK	
BMWG18053GB	MWG PRESSURE VESSEL 18X53 4" BLUE	44	420	OK	
BMWG18065GB	MWG PRESSURE VESSEL 18X65 4" BLUE	44	420	OK	
BMWG21036GB	MWG PRESSURE VESSEL 21X36 4" BLUE	44	420	OK	
BMWG21053GB	MWG PRESSURE VESSEL 21X53 4" BLUE	44	420	OK	
BMWG21062GB	MWG PRESSURE VESSEL 21X62 4" BLUE	44	420	OK	
BMWG24065GB	MWG PRESSURE VESSEL 24X65 4" BLUE	44	420	OK	
BMWG24072GB	MWG PRESSURE VESSEL 24X72 4" BLUE	44	420	OK	
BMWG30072GB	MWG PRESSURE VESSEL 30X72 4" BLUE	44	420	OK	
BMWG36072GB	MWG PRESSURE VESSEL 36X72 4" BLUE	44	420	OK	

Ref	Volume (Liters)	External D (mm)	A (mm)	B (mm)	Connection (Inch)
BMWG14052GB	112	360	1325 ± 6	369	4"
BMWG14065GB	142	360	1657 ± 6	369	4"
BMWG16052GB	147	410	1312 ± 6	420	4"
BMWG16065GB	188	410	1648 ± 6	420	4"
BMWG18053GB	189	464	1366 ± 6	451	4"
BMWG18065GB	236	464	1670 ± 6	451	4"
BMWG21036GB	167	540	958 ± 10	532	4"
BMWG21053GB	258	540	1390 ± 10	532	4"
BMWG21062GB	307	540	1620 ± 10	532	4"
BMWG24065GB	424	615	1720 ± 10	612	4"
BMWG24072GB	474	615	1900 ± 10	612	4"
BMWG30072GB	716	767	1890 ± 10	752	4"
BMWG36072GB	1008	920	1965 ± 10	910	4"

Ref	Box: WxLxH.	Box: Q.ty	Box: Weight.	Pallet: WxLxH.	Pallet: Q.ty	Pallet: Weight.
BMWG14052GB						
BMWG14065GB						
BMWG16052GB						
BMWG16065GB						
BMWG18053GB						
BMWG18065GB						
BMWG21036GB						
BMWG21053GB						
BMWG21062GB						
BMWG24065GB						
BMWG24072GB						
BMWG30072GB						
BMWG36072GB						

Certificates	Manufacturer	Sectors
DM174-2004 ACS KTW CE, EAC	<b>MWG</b>	Commercial, Industrial





## Structural Industrial Pressure Vessels With Threaded Top Opening

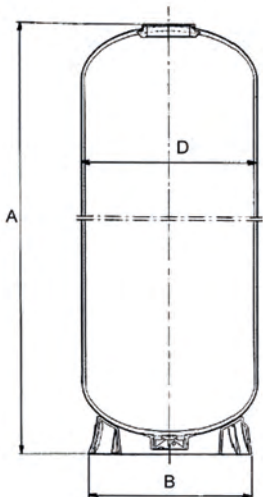

- Made in European Union (Belgium); composite pressure vessels PE liner reinforced with fiberglass and epoxy resin; for industrial and potable water treatment systems;
- European 2014/68/EU Directive compliant for pressure equipment (PED);
- Max operating pressure 10 bar; Max operating temperature 50°C;
- Threaded top connection 4" - 8UN;
- Cycle test 250.000 times from 0,7 to 10 bar; burst test to 4 times max operating pressure;
- Warranty 5 years;
- **Note:** vacuum breaker and flexible connection mounting are highly recommended.

Ref	Description	Fam.	Subfam.	Disp. Stock	
BSRT1452A3REN	STRUCTURAL PRESSURE VESSEL 14X52 4" BLU	44	440	NO	
BSRT1465A3REN	STRUCTURAL PRESSURE VESSEL 14X65 4" BLU	44	440	OK	
BSRT1649A3REN	STRUCTURAL PRESSURE VESSEL 16X49 4" BLU	44	440	OK	
BSRT1665A3REN	STRUCTURAL PRESSURE VESSEL 16X65 4" BLU	44	440	OK	
BSRT1865A3EN	STRUCTURAL PRESSURE VESSEL 18X65 4" BLUE	44	440	OK	
BSRT2160A3E	STRUCTURAL PRESSURE VESSEL 21X60 4" BLUE	44	440	OK	

Ref	Volume (liters)	External D (mm)	A (mm)	B (mm)	Connection (Inch)
BSRT1452A3REN	122	369	1360 ± 20	330	4"
BSRT1465A3REN	140	369	1645 ± 20	380	4"
BSRT1649A3REN	125	406	1269 ± 20	420	4"
BSRT1665A3REN	170	406	1632 ± 20	420	4"
BSRT1865A3EN	250	469	1726 ± 20	510	4"
BSRT2160A3E	307	552	1630 ± 20	510	4"

Ref	Box: WxLxH.	Box: Q.ty	Box: Weight.	Pallet: WxLxH.	Pallet: Q.ty	Pallet: Weight.
BSRT1452A3REN						
BSRT1465A3REN						
BSRT1649A3REN						
BSRT1665A3REN						
BSRT1865A3EN						
BSRT2160A3E						

Certificates	Manufacturer	Sectors
DM174-2004 ACS KTW WRAS CE, EAC	Pentair	Commercial, Industrial



## MWG Industrial Pressure Vessels With Top&Bottom Threaded Openings

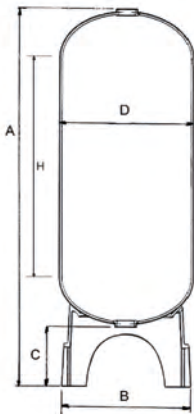

- Made in China;
- Composite pressure vessels PE liner reinforced with fiberglass and epoxy resin;
- For industrial and potable water treatment systems;
- European 2014/68/EU Directive compliant for pressure equipment (PED);
- Max operating pressure 10 bar;
- Max operating temperature 50°C;
- Top and bottom threaded connection 4"- 8UN; Cycle test 100.000 times from 0 to 10,5 bar;
- Burst test to 4 times max operating pressure;
- Blue colour;
- Warranty 10 years;
- Pressure vessels 30" and greater are shipped with vacuum breaker;
- **Note:** vacuum breaker and flexible connection mounting are highly recommended.

Ref	Description	Fam.	Subfam.	Disp. Stock	
BMWG14065HB	MWG PRESSURE VESSEL 14X65 4" + 4" BLUE	44	420	OK	
BMWG16065HB	MWG PRESSURE VESSEL 16X65 4" + 4" BLUE	44	420	OK	
BMWG18065HB	MWG PRESSURE VESSEL 18X65 4" + 4" BLUE	44	420	OK	
BMWG21062HB	MWG PRESSURE VESSEL 21X62 4" + 4" BLUE	44	420	OK	
BMWG24065HB	MWG PRESSURE VESSEL 24X65 4" + 4" BLUE	44	420	OK	
BMWG24072HB	MWG PRESSURE VESSEL 24X72 4" + 4" BLUE	44	420	OK	
BMWG30072HB	MWG PRESSURE VESSEL 30X72 4" + 4" BLUE	44	420	OK	
BMWG36072HB	MWG PRESSURE VESSEL 36X72 4" + 4" BLUE	44	420	OK	

Ref	Volume (Liters)	External D (mm)	A (mm)	B (mm)	C (mm)	H (mm)	Connection (Inch)
BMWG14065HB	148,5	360	1856 ± 6	369	230	1386	4"
BMWG16065HB	192	410	1880 ± 6	430	250	1365	4"
BMWG18065HB	236	464	1950 ± 10	480	320	1330	4"
BMWG21062HB	307	540	1902 ± 10	555	330	1220	4"
BMWG24065HB	424	615	1916 ± 10	610	246	1220	4"
BMWG24072HB	474	615	2090 ± 10	610	240	1400	4"
BMWG30072HB	716	767	2077 ± 10	762	235	1270	4"
BMWG36072HB	1008	920	2200 ± 10	930	350	1170	4"

Ref	Box: WxLxH.	Box: Q.ty	Box: Weight.	Pallet: WxLxH.	Pallet: Q.ty	Pallet: Weight.
BMWG14065HB						
BMWG16065HB						
BMWG18065HB						
BMWG21062HB						
BMWG24065HB						
BMWG24072HB						
BMWG30072HB						
BMWG36072HB						

Certificates	Manufacturer	Sectors
DM174-2004 ACS KTW CE, EAC	<b>MWG</b>	Commercial, Industrial



## Structural Industrial Pressure Vessels With Top&Bottom Threaded Openings



- Made in European Union (Belgium);
- Composite pressure vessels PE liner reinforced with fiberglass and epoxy resin;
- For industrial and potable water treatment systems;
- European 2014/68/EU Directive compliant for pressure equipment (PED);
- Max operating pressure 10 bar;
- Max operating temperature 50°C;
- Top and bottom threaded connection 4" - 8UN;
- Cycle test 250.000 times from 0,7 to 10 bar;
- Burst test to 4 times max operating pressure;
- Blue colour;
- Warranty 5 years;
- Pressure vessels 30" and greater are shipped with vacuum breaker;
- **Attention:** BSRT1865F7E pressure vessel is available with standard base only (not Tripod);
- **Note:** vacuum breaker and flexible connection mounting are highly recommended.

Ref	Description	Fam.	Subfam.	Disp. Stock	
BSRT1865F7E	STRUCTURAL PRESSURE VESSEL 18X65 4" + 4" BLUE	44	440	OK	
BSRT2160F7E	STRUCTURAL PRESSURE VESSEL 21X60 4" + 4" BLUE	44	440	OK	
BSRT2469F7E	STRUCTURAL PRESSURE VESSEL 24X69 4" + 4" BLUE	44	440	OK	
BSRT3072F7E	STRUCTURAL PRESSURE VESSEL 30X72 4" + 4" BLUE	44	440	OK	
BSRT3672F7E	STRUCTURAL PRESSURE VESSEL 36X72 4" + 4" BLUE	44	440	OK	

Ref	Volume (liters)	External D (mm)	A (mm)	B (mm)	C (mm)	H (mm)	Connection (Inch)
BSRT1865F7E	247	473	1885 ± 20	539	217	1342	4"
BSRT2160F7E	310	552	1923 ± 20	539	389	1155	4"
BSRT2469F7E	440	610	2169 ± 20	620	422	1327	4"
BSRT3072F7E	710	770	2248 ± 30	816	413	1313	4"
BSRT3672F7E	1020	927	2305 ± 30	1001	408	1266	4"

Ref	Box: WxLxH.	Box: Q.ty	Box: Weight.	Pallet: WxLxH.	Pallet: Q.ty	Pallet: Weight.
BSRT1865F7E						
BSRT2160F7E						
BSRT2469F7E						
BSRT3072F7E						
BSRT3672F7E						

Certificates	Manufacturer	Sectors
DM174-2004 ACS KTW WRAS CE, EAC	Pentair	Commercial, Industrial

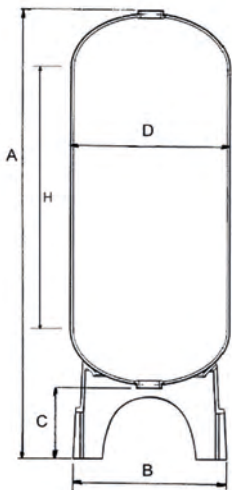



## MWG Pressure Vessels With Flanged Top Opening



- Made in China;
- Composite pressure vessels PE liner reinforced with fiberglass and epoxy resin;
- For industrial and potable water treatment systems;
- European 2014/68/EU Directive compliant for pressure equipment (PED);
- Max operating pressure 10 bar;
- Max operating temperature 50°C;
- 6" top connection;
- Cycle test 100.000 times from 0 to 10,5 bar;
- Burst test to 4 times max operating pressure;
- Blue colour;
- Warranty 10 years;
- Pressure vessels 30" and bigger are shipped with vacuum breaker;
- **Note:** vacuum breaker and flexible connection mounting are highly recommended.

Ref	Description	Fam.	Subfam.	Disp. Stock	
BMWG18068LB	MWG PRESSURE VESSEL 18X68 6" BLUE	44	422	OK	
BMWG21066LB	MWG PRESSURE VESSEL 21X66 6" BLUE	44	422	OK	
BMWG24075LB	MWG PRESSURE VESSEL 24X75 6" BLUE	44	422	OK	
BMWG30078LB	MWG PRESSURE VESSEL 30X78 6" BLUE	44	422	OK	
BMWG36078LB	MWG PRESSURE VESSEL 36X78 6" BLUE	44	422	OK	

Ref	Volume (Liters)	External D (mm)	A (mm)	B (mm)	H (mm)	Connection (Inch)
BMWG18068LB	264	469	1850 ± 25	451	1451	6"
BMWG21066LB	322	544	1745 ± 25	530	1254	6"
BMWG24075LB	460	617	1905 ± 25	612	1404	6"
BMWG30078LB	781	772	2060 ± 25	752	1485	6"
BMWG36078LB	1136	923	2170 ± 25	910	1428	6"

Ref	Box: WxLxH.	Box: Q.ty	Box: Weight.	Pallet: WxLxH.	Pallet: Q.ty	Pallet: Weight.
BMWG18068LB						
BMWG21066LB						
BMWG24075LB						
BMWG30078LB						
BMWG36078LB						

Certificates	Manufacturer	Sectors
DM174-2004 ACS KTW CE, EAC	<b>MWG</b>	Industrial

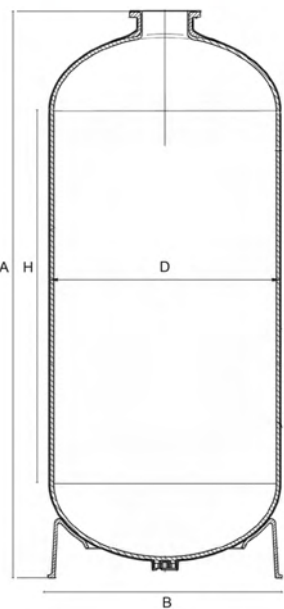



## MWG Industrial Pressure Vessels With Flanged Top&Bottom Openings

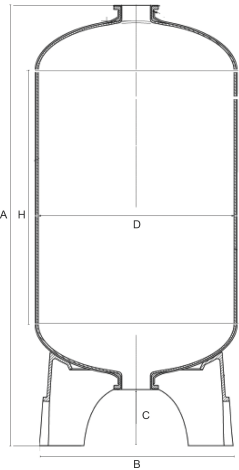
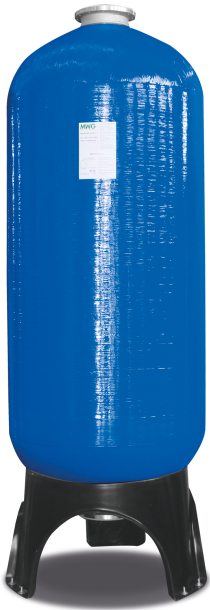

- Made in China;
- Composite pressure vessels PE liner reinforced with fiberglass and epoxy resin;
- For industrial and potable water treatment systems;
- European 2014/68/EU Directive compliant for pressure equipment (PED);
- Max operating pressure 10 bar;
- Max operating temperature 50°C;
- Top and bottom 6" flange connection;
- Cycle test 100.000 times from 0 to 10,5 bar;
- Burst test to 4 times max operating pressure; Blue colour;
- Warranty 10 years;
- Pressure vessels 30" and bigger are shipped with vacuum breaker;
- **Note:** vacuum breaker and flexible connection mounting are highly recommended.

Ref.	Description	Fam.	Subfam.	Disp. Stock	
BMWG18068MB	MWG PRESSURE VESSEL 18X68 6" + 6" BLUE	44	422	OK	
BMWG21066MB	MWG PRESSURE VESSEL 21X66 6" + 6" BLUE	44	422	OK	
BMWG24075MB	MWG PRESSURE VESSEL 24X75 6" + 6" BLUE	44	422	OK	
BMWG30072MB	MWG PRESSURE VESSEL 30X72 6" + 6" BLUE	44	422	OK	
BMWG36072MB	MWG PRESSURE VESSEL 36X72 6" + 6" BLUE	44	422	OK	
BMWG42063PB	MWG PRESSURE VESSEL 42X63 6"+6" BLUE	44	422	OK	
BMWG42072MB	MWG PRESSURE VESSEL 42X72 6" + 6" BLUE	44	422	NO	
BMWG42072PB	MWG PRESSURE VESSEL 42X72 6" + 6" BLUE	44	422	OK	
BMWG48072MB	MWG PRESSURE VESSEL 48X72 6" + 6" BLUE	44	422	NO	
BMWG48072PB	MWG PRESSURE VESSEL 48X72 6" + 6" BLUE	44	422	OK	
BMWG63067MB	MWG PRESSURE VESSEL 63X67 6" + 6" BLUE	44	422	NO	
BMWG63067PB	MWG PRESSURE VESSEL 63X67 6" + 6" BLUE	44	422	OK	
BMWG63086MB	MWG PRESSURE VESSEL 63X86 6" + 6" BLUE	44	422	NO	
BMWG63086PB	MWG PRESSURE VESSEL 63X86 6" + 6" BLUE	44	422	OK	

Ref.	Volume (litres)	External D (mm)	A (mm)	B (mm)	C (mm)	H (mm)	Connection (inch)
BMWG18068MB	264	469	2120 ± 25	480	250	1451	6"
BMWG21066MB	322	544	2010 ± 25	554	260	1254	6"
BMWG24075MB	460	617	2180 ± 25	650	265	1404	6"
BMWG30072MB	716	767	2240 ± 25	815	265	1260	6"
BMWG36072MB	1036	920	2270 ± 25	920	275	1195	6"
BMWG42063PB	1224	1085	2145 ± 25	1060	365	955	6"
BMWG42072MB	1425	1085	2285 ± 25	1060	270	1185	6"
BMWG42072PB	1425	1085	2375 ± 25	1060	365	1185	6"
BMWG48072MB	1746	1220	2270 ± 25	1230	260	1110	6"
BMWG48072PB	1746	1220	2365 ± 25	1230	365	1110	6"
BMWG63067MB	2623	1620	2050 ± 25	1620	265	660	6"
BMWG63067PB	2623	1620	2120 ± 25	1590	330	660	6"
BMWG63086MB	3417	1620	2480 ± 25	1620	265	1100	6"
BMWG63086PB	3296	1620	2465 ± 25	1590	330	1100	6"

Certificates	Manufacturer	Sectors
DM174-2004 ACS KTW CE, EAC	<b>MWG</b>	Industrial



## Structural Industrial Pressure Vessels With Flanged Top&Bottom Openings

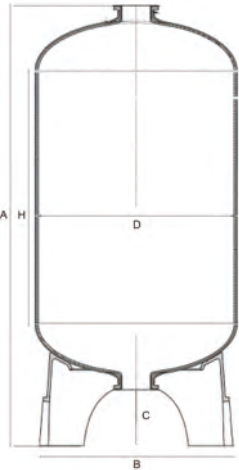

- Made in European Union (Belgium);
- Composite pressure vessels PE liner reinforced with fiberglass and epoxy resin;
- For industrial and potable water treatment systems;
- European 2014/68/EU Directive compliant for pressure equipment (PED);
- Max operating pressure 10 bar;
- Max operating temperature 65°C;
- Top and bottom 6" flange connection;
- Cycle test 250.000 times from 0,7 to 10 bar;
- Burst test to 4 times max operating pressure;
- Blue colour; Warranty 5 years;
- Pressure vessels 30" and bigger are shipped with vacuum breaker;
- **Note:** vacuum breaker and flexible connection mounting are highly recommended.

Ref	Description	Fam.	Subfam.	Disp. Stock	
BSC3678F7	STRUCTURAL PRESSURE VESSEL 36X78 6" + 6" BLUE	44	442	OK	
BSC4278F7	STRUCTURAL PRESSURE VESSEL 42X78 6" + 6" BLUE	44	442	OK	
BSC4882F7	STRUCTURAL PRESSURE VESSEL 48X82 6" + 6" BLUE	44	442	OK	
BSRT6367F7E	STRUCTURAL PRESSURE VESSEL 63X67 6" + 6" BLUE	44	442	OK	
BSRT6386F7E	STRUCTURAL PRESSURE VESSEL 63X86 6" + 6" BLUE	44	442	OK	

Ref	Volume (litres)	External D (mm)	A (mm)	B (mm)	C (mm)	H (mm)	Connection (Inch)
BSC3678F7	1026	923	2340 ± 30	955	370	1245	6"
BSC4278F7	1325	1068	2425 ± 40	1092	435	1140	6"
BSC4882F7	1792	1213	2440 ± 40	1270	408	1124	6"
BSRT6367F7E	2414	1620	2345 ± 40	1570	650	573	6"
BSRT6386F7E	3208	1620	2745 ± 40	1570	650	973	6"

Ref	Box: WxLxH.	Box: Q.ty	Box: Weight.	Pallet: WxLxH.	Pallet: Q.ty	Pallet: Weight.
BSC3678F7						
BSC4278F7						
BSC4882F7						
BSRT6367F7E						
BSRT6386F7E						

Certificates	Manufacturer	Sectors
DM174-2004 ACS KTW WRAS CE, EAC	Pentair	Industrial



## Pressure Vessels Accessories

### Adapters



- adapter 4"- 8UN to 2 1/2" - 8NPSM;
- with O-ring.

Ref	Description	Fam.	Subfa m.	Disp. Stock	
PV300	ADAPTER 4"x2.1/2"NPSM W/O-RING	45	201	OK	
PV300A	STRUCTURAL ADAPTER 4"x2.1/2" NPSM W/ O-RING - P/NCH4821-2	45	201	NO	
PV300B	ADAPTER 4"x2.1/2" MWG WITH O-RING	45	201	OK	
PV307	PVC ADAPTER 4"-8UN X 2" BSP	45	201	OK	

Ref	Description	Material	Reduction to
PV300	ADAPTER 4"x2.1/2"NPSM W/O-RING	PVC machined	2 1/2" - 8 NPSM
PV300A	STRUCTURAL ADAPTER 4"x2.1/2" NPSM W/ O-RING - P/NCH4821-2	PVC-C	2 1/2" - 8 NPSM
PV300B	ADAPTER 4"x2.1/2" MWG WITH O-RING	ABS	2 1/2" - 8 NPSM
PV307	PVC ADAPTER 4"-8UN X 2" BSP	PVC machined	2" BSP

### Closures



- closure for 4"- 8UN tanks thread;
- with O-ring.

Ref	Description	Fam.	Subfa m.	Disp. Stock	
PV301	CLOSURE 4"-8UN W/ O-RING	45	201	OK	

Ref	Description	Material
PV301	CLOSURE 4"-8UN W/ O-RING	PVC machined

### 6" closed flange



- Closed flange complete with bolts, nuts, washer and O-ring;
- Flange material PVC;
- Bolts material AISI 304.

Ref	Description	Fam.	Subfa m.	Disp. Stock	
PV510B	6" PVC FLANGED CLOSURE W/ O-RING AND SCREWS*	45	201	OK	

### 6" - 4" adapter



- 6" flanged adapter 4"-8UN, complete with bolts, nuts, washer and O-ring;
- Bolts material AISI 304.

Ref	Description	Fam.	Subfa m.	Disp. Stock	
PV511B	FLANGED ADAPTER 6"-4" 8UN W/ O-RING AND SCREWS*	45	201	OK	

Ref	Description	Adapter material
PV511B	FLANGED ADAPTER 6"-4" 8UN W/ O-RING AND SCREWS*	PVC





## Aeration valve & vacuum breaker



- Aeration valve and vacuum breaker in PP;
- Max pressure 10 bar;
- Max temperature 65°C;
- PV308 connection 1 1/2", drain 1/2";
- PV308B connection 1", drain 3/4".

Ref	Description	Fam.	Subfam.	Disp. Stock	
PV308	AERATION VALVE AND VACUUM BREAKER 1"1/2	45	201	OK	
PV308B	MWG AERATION VALVE AND VACUUM BREAKER 1"	45	201	OK	

## Cylindrical diffusers



- Cylindrical diffuser for vessels with 4"- 8UN, for upper or lower installation;
- Outlet connection to glue D.63;
- 0,2 mm slots or 0,5 mm;
- Materials: adapter PVC., diffuser PP;
- Flow 20 m3/h at Δp 0,2 bar;
- A. union D63 (REF. PV329);
- B. adapter 4" with gasket (REF. PV332);
- C. reduction 2" M/F (REF. PV335);
- D. diffuser diameter 85 mm length 180 mm.(REF. PV340 0,2 mm slots - REF. PV342 0,5 mm slots).

Ref	Description	Fam.	Subfam.	Disp. Stock	
PV351	TOP/BOTTOM CYLINDRICAL DISTRIBUTOR 4"-8UN D.63 PIPE UNION DIFF. 0,2 MM*	45	201	OK	
PV352	TOP/BOTTOM CYLINDRICAL DISTRIBUTOR 4"-8UN D.63 PIPE UNION DIFF. 0,5 MM*	45	201	OK	

Ref	Description	Fessure (mm)	Ø Bombole abbinabili
PV351	TOP/BOTTOM CYLINDRICAL DISTRIBUTOR 4"-8UN D.63 PIPE UNION DIFF. 0,2 MM*	0,2	14" ÷ 36"
PV352	TOP/BOTTOM CYLINDRICAL DISTRIBUTOR 4"-8UN D.63 PIPE UNION DIFF. 0,5 MM*	0,5	14" ÷ 36"

Certificates	Manufacturer	Sectors
		Industrial

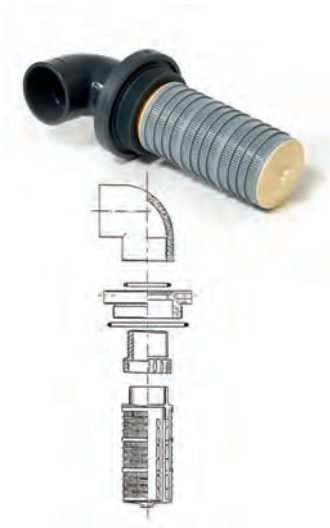

### Cylindrical diffusers with elbow

- Cylindrical diffuser for vessel 4"-8UN, for upper installation;
- Outlet connection with elbow to glue D63;
- 0,2 mm slots or 0,5 mm
- Materials: adapter and elbow PVC, diffuser PP;
- Flow 20 m<sup>3</sup>/h at Δp 0,2 bar;
- Including:
  - A. elbow D63 (REF. PV331);
  - B. adapter 4" with gasket (REF. PV332);
  - C. reduction 2" M/F (REF. PV335);
  - D. diffuser con diameter 85 mm length 180 mm (REF.PV340 0,2 mm slots - REF.PV342 0,5 mm slots).

Ref	Description	Fam.	Subfam.	Disp. Stock	
PV350	TOP CYLINDRICAL DISTRIBUTOR 4"-8UN X DN63 ELBOW DIFF. 0,2MM*	45	201	OK	
PV349	TOP CYLINDRICAL DISTRIBUTOR 4"-8UN X DN63 ELBOW DIFF. 0,5MM*	45	201	OK	

Ref	Description	Slots (mm)	Ø Vessel
PV350	TOP CYLINDRICAL DISTRIBUTOR 4"-8UN X DN63 ELBOW DIFF. 0,2MM*	0,2	14" ÷ 36"
PV349	TOP CYLINDRICAL DISTRIBUTOR 4"-8UN X DN63 ELBOW DIFF. 0,5MM*	0,5	14" ÷ 36"

Certificates	Manufacturer	Sectors
		Industrial

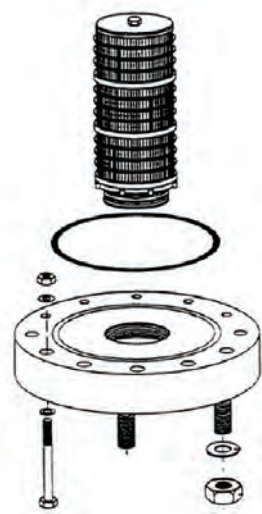

## Flanged upper diffusers

- Upper diffuser 6" flanged, complete with bolts, nuts, washer and O-ring;
- Flange material PVC;
- PP cylindrical diffuser 0,2 mm slots or 0,5 mm slots;
- Bolts material AISI 304.

Ref	Description	Fam.	Subfam.	Disp. Stock	
PV512	TOP CYLINDRICAL DISTRIBUTOR FLANGED 6" X DN 65 DIFF. 0,2MM - 284 MM*	45	201	OK	
PV514	TOP CYLINDRICAL DISTRIBUTOR FLANGED 6" X DN80 DIFF. 0,2MM - 240 MM*	45	201	OK	
PV515	TOP CYLINDRICAL DISTRIBUTOR FLANGED 6" X DN80 DIFF. 0,2 MM - 312 MM*	45	201	OK	
PV553	CYLINDRICAL DISTRIBUTOR FLANGED 6" DN 80 DIFF. 0,2 MM - 384 MM *	45	201	OK	
PV518	TOP CYLINDRICAL DISTRIBUTOR FLANGED 6" DN100 DIFF,0,2 MM - 384 MM*	45	201	OK	
PV513	TOP CYLINDRICAL DISTRIBUTOR FLANGED 6" X DN 65 DIFF. 0,5MM - 284 MM*	45	201	OK	
PV516	TOP CYLINDRICAL DISTRIBUTOR FLANGED 6" DN80 DIFF0,5 MM - 240 MM*	45	201	OK	
PV517	TOP CYLINDRICAL DISTRIBUTOR FLANGED 6" DN80 DIFF0,5 MM - 312 MM*	45	201	OK	
PV554	CYLINDRICAL DISTRIBUTOR FLANGED 6" DN 80 DIFF. 0,5 MM - 384 MM *	45	201	OK	
PV519	TOP CYLINDRICAL DISTRIBUTOR FLANGED 6" DN100 DIFF0,5 MM - 384 MM*	45	201	OK	

Ref	Ø VESSEL	Ø Cylindrical diffuser (mm)	Cylindrical diffuser Length (mm)	Slots (mm)	Flow (m³/h) Δp 0,2 bar
PV512	18" ÷ 36"	85	284	0,2	25
PV514	24" ÷ 36"	120	240	0,2	35
PV515	42" ÷ 48"	120	312	0,2	40
PV553	63"	120	384	0,2	45
PV518	63"	120	384	0,2	60
PV513	18" ÷ 36"	85	284	0,5	25
PV516	24" ÷ 36"	120	240	0,5	35
PV517	42" ÷ 48"	120	312	0,5	40
PV554	63"	120	384	0,5	45
PV519	63"	120	384	0,5	60

Certificates	Manufacturer	Sectors
		Industrial



## Pressure Vessels Accessories

### Cylindrical diffusers

- PP cylindrical diffuser with thread connection 2", 3" or 4";
- Slots 0,2 or 0,5 mm.



Ref	Description	Fam.	Subfam.	Disp. Stock	
PV340	CYLINDRICAL DIFFUSER 2" L=180-0.2 MM	45	201	OK	
PV339	CYLINDRICAL DIFFUSER 2" L=284 - 0,2MM	45	201	OK	
PV341	CYLINDRICAL DIFFUSER 2" L=338 - 0,2MM	45	201	OK	
PV342	CYLINDRICAL DIFFUSER 2" L=180 - 0,5MM	45	201	OK	
PV343	CYLINDRICAL DIFFUSER 2" L=284 - 0,5MM	45	201	OK	
PV344	CYLINDRICAL DIFFUSER 2" L=338 - 0,5MM	45	201	OK	
PV364	CYLINDRICAL DIFFUSER 3" L=240 - 0,2MM	45	201	OK	
PV365	CYLINDRICAL DIFFUSER 3" L=312 - 0,2 MM	45	201	OK	
PV366	CYLINDRICAL DIFFUSER 3" L=384 - 0,2 MM	45	201	OK	
PV367	CYLINDRICAL DIFFUSER 3" L=240 - 0,5 MM	45	201	OK	
PV368	CYLINDRICAL DIFFUSER 3" L=312 - 0,5 MM	45	201	OK	
PV369	CYLINDRICAL DIFFUSER 3" L=384 - 0,5 MM	45	201	OK	
PV393	CYLINDRICAL DIFFUSER 4" 8UN L=384 - 0,2 MM	45	201	OK	
PV394	CYLINDRICAL DIFFUSER 4" 8UN L=384 - 0,5 MM	45	201	OK	

Ref	Connection	Ø Diameter(mm)	Lenght(mm)	Slots (mm)
PV340	2"	85	180	0,2
PV339	2"	85	284	0,2
PV341	2"	85	338	0,2
PV342	2"	85	180	0,5
PV343	2"	85	284	0,5
PV344	2"	85	338	0,5
PV364	3"	120	240	0,2
PV365	3"	120	312	0,2
PV366	3"	120	384	0,2
PV367	3"	120	240	0,5
PV368	3"	120	312	0,5
PV369	3"	120	384	0,5
PV393	4"	120	384	0,2
PV394	4"	120	384	0,5

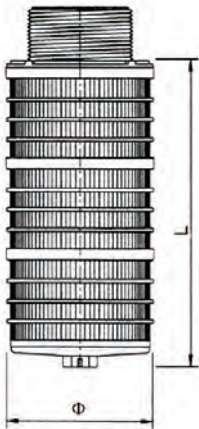

Certificates	Manufacturer	Sectors
		Industrial



## Lower lateral system

- Lower lateral system for vessels with 4" - 8UN opening;
- Outlet connection to glue D63;
- Slots 0,2 or 0,5 mm;
- Materials: adapter PVC, hub and laterals PP;
- Including:
  - A. union D63 (REF. PV329);
  - B. adapter 4" with O-rings (REF. PV332);
  - C. reduction 2" M/F (REF. PV335);
  - D. n.3 spacers (REF. PV337);
  - E. hub (REF. PV336);
  - F. N.5 laterals diameter 54 mm, length = see table.

Ref	Description	Fam.	Subfam.	Disp. Stock	
PV353	LOWER LATERAL SYSTEM 4"-8UN X D.63 PRES.VES. 14"-16"-18" SLOTS 0,2 MM*	45	201	OK	
PV354	LOWER LATERAL SYSTEM 4"-8UN X D.63 PRES.VES.21"-24" SLOTS 0,2 MM*	45	201	OK	
PV355	LOWER LATERAL SYSTEM 4"-8UN X D.63 PRES.VES.30" SLOTS 0,2 MM*	45	201	OK	
PV356	LOWER LATERAL SYSTEM 4"-8UN X D.63 PRES.VES.36" SLOTS 0,2 MM*	45	201	OK	
PV360	LOWER LATERAL SYSTEM 4"-8UN X D.63 PRES.VES.14"-16"-18" SLOTS 0,5MM*	45	201	OK	
PV361	LOWER LATERAL SYSTEM 4"-8UN X D.63 PRES.VES.21"-24" SLOTS 0,5MM*	45	201	OK	
PV362	LOWER LATERAL SYSTEM 4"-8UN X D.63 PRES.VES.30" SLOTS 0,5MM*	45	201	OK	
PV363	LOWER LATERAL SYSTEM 4"-8UN X D.63 PRES.VES.36" SLOTS 0,5MM*	45	201	OK	

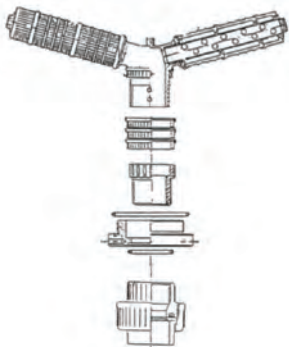

Ref	Slots (mm)	Ø Vessel	Flow(m³/h) Δp 0,2 bar	Lateral lenght (mm)
PV353	0,2	14" - 16" - 18"	17	113
PV354	0,2	21" - 24"	18	175
PV355	0,2	30"	19	237
PV356	0,2	36"	20	299
PV360	0,5	14" - 16" - 18"	17	113
PV361	0,5	21" - 24"	18	175
PV362	0,5	30"	19	237
PV363	0,5	36"	20	299

Certificates	Manufacturer	Sectors
		Industrial



## Pressure Vessels Accessories

### Lower lateral systems with 6 laterals hub for flanged pressure vessels



- Lower lateral system for 6" flanged pressure vessels;
- Flange material PVC;
- Complete with AISI 304 bolts and washer;
- Hub at 6 laterals;
- Laterals in PP, slots 0,2 or 0,5 mm, length as table below.

Ref	Description	Fam.	Subfam.	Disp. Stock	
PV520	LOWER LATERAL SYSTEM FLANG. 6" DN65 PRES.VES. 18"-21" SLOTS 0,2MM*	45	201	OK	
PV521	LOWER LATERAL SYSTEM FLANG. 6" DN65 PRES.VES.24"SLOTS 0,2MM*	45	201	OK	
PV522	LOWER LATERAL SYSTEM FLANG. 6" DN65 PRES.VES.30"SLOTS 0,2MM*	45	201	OK	
PV523	LOWER LATERAL SYSTEM FLANG. 6" DN65 PRES.VES.36"SLOTS 0,2MM*	45	201	OK	
PV524	LOWER LATERAL SYSTEM FLANG. 6"-DN65 PRES.VES. 18"-21" DIFF. 0,5MM*	45	201	OK	
PV525	LOWER LATERAL SYSTEM FLANG. 6" DN65 PRES.VES.24"SLOTS 0,5MM*	45	201	OK	
PV526	LOWER LATERAL SYSTEM FLANG. 6" DN65 PRES.VES. 30"SLOTS 0,5MM*	45	201	OK	
PV527	LOWER LATERAL SYSTEM FLANG. 6" DN65 PRES.VES.36"SLOTS 0,5MM*	45	201	OK	

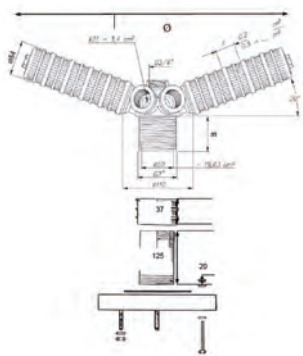

Ref	Ø Vessel	Connection	Lateral lenght (mm)	Ø Diameter (mm)	Slots (mm)	Flow (m³/h) Δ0,2 bar p
PV520	18" - 21"	DN 65	144	374	0,2	22
PV521	24"	DN 65	175	432	0,2	23
PV522	30"	DN 65	237	549	0,2	24
PV523	36"	DN 65	299	665	0,2	25
PV524	18" - 21"	DN 65	144	374	0,5	22
PV525	24"	DN 65	175	432	0,5	23
PV526	30"	DN 65	237	549	0,5	24
PV527	36"	DN 65	299	665	0,5	25

Certificates	Manufacturer	Sectors
		Industrial



## Lower lateral systems with 8 laterals hub for flanged pressure vessels

- Lower lateral system for 6" flanged pressure vessels;
- Flange material PVC;
- Complete with AISI 304 bolts and washer;
- Hub at 8 laterals;
- Laterals in PP, slots 0,2 or 0,5 m

Ref	Description	Fam.	Subfam.	Disp. Stock	
PV522A	LOWER LATERAL SYSTEM FLANG. 6" -DN65 HF PRES.VES.30" DIFF. 0,2MM*	45	201	OK	
PV523A	LOWER LATERAL SYSTEM FLANG. 6" DN65 HF PRES.VES.36" SLOTS 0,2MM*	45	201	OK	
PV528	LOWER LATERAL SYSTEM FLANG. 6" DN80 PRES.VES.24"SLOTS 0,2MM*	45	201	OK	
PV529	LOWER LATERAL SYSTEM FLANG. 6" DN80 PRES.VES.30"SLOTS 0,2MM*	45	201	OK	
PV530	LOWER LATERAL SYSTEM FLANG. 6" DN80 PRES.VES.36"SLOTS 0,2MM*	45	201	OK	
PV526A	LOWER LATERAL SYSTEM FLANG. 6" DN65 HF PRES.VES.30" SLOTS 0,5MM*	45	201	OK	
PV527A	LOWER LATERAL SYSTEM FLANG. 6" DN65 HF PRES.VES.36" SLOTS 0,5MM*	45	201	OK	
PV531	LOWER LATERAL SYSTEM FLANG. 6" DN80 PRES.VES.24"SLOTS 0,5MM*	45	201	OK	
PV532	LOWER LATERAL SYSTEM FLANG. 6" DN80 PRES.VES.30"SLOTS 0,5MM*	45	201	OK	
PV533	LOWER LATERAL SYSTEM FLANG. 6" DN80 PRES.VES.36"SLOTS 0,5MM*	45	201	OK	

Ref	Ø Vessel	Connection	Lateral lenght (mm)	Ø Diameter	Slots (mm)	Flow (m³/h) Δp 0,2 bar
PV522A	30"	DN 65	237	580	0,2	25
PV523A	36"	DN 65	299	699	0,2	30
PV528	24"	DN 80	175	461	0,2	34
PV529	30"	DN 80	237	580	0,2	36
PV530	36"	DN 80	299	699	0,2	38
PV526A	30"	DN 65	237	580	0,5	25
PV527A	36"	DN 65	299	699	0,5	30
PV531	24"	DN 80	175	461	0,5	34
PV532	30"	DN 80	237	580	0,5	36
PV533	36"	DN 80	299	699	0,5	38

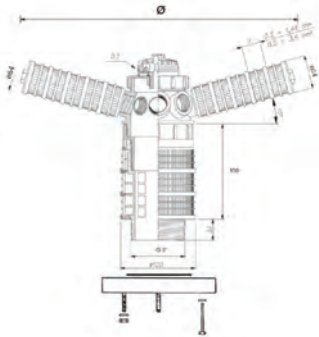

Certificates	Manufacturer	Sectors
		Industrial





## Pressure Vessels Accessories

### Lower double lateral systems for flanged pressure vessels

- Lower double lateral system for 6" flanged pressure vessels;
- Flange material PVC, bolts in AISI 304;
- Complete with bolts and washer;
- Double hub at 8 + 8 laterals;
- Laterals in PP, slots 0,2 or 0,5 mm, length as table below.



Ref	Description	Fam.	Subfam.	Disp. Stock	
PV555	LOWER LATERAL SYSTEM FLANG. 6" DN80 PRES.VES.63"SLOTS 0,2 MM*	45	201	OK	
PV538	LOWER LATERAL SYSTEM FLANG 6" DN100 PRES. VES. 63" DIFF 0,2 MM*	45	201	OK	
PV556	LOWER LATERAL SYSTEM FLANG. 6" DN80 PRES.VES.63"SLOTS 0,5 MM*	45	201	OK	
PV539	LOWER LATERAL SYSTEM FLANG. 6" DN100 PRES.VES.63"SLOTS 0,5 MM*	45	201	OK	

Ref	Lateral quantity	A (mm)	Slots (mm)	Flow (m3/h) Δp 0,2 bar	Diffusor lenght (mm)	Ø System diameter (mm)
PV555	8 + 8	190	0,2	45	578-640	1239-1359
PV538	8 + 8	190	0,2	60	578-640	1239-1359
PV556	8 + 8	190	0,5	45	578-640	1239-1359
PV539	8 + 8	190	0,5	60	578-640	1239-1359

Certificates	Manufacturer	Sectors
		Industrial

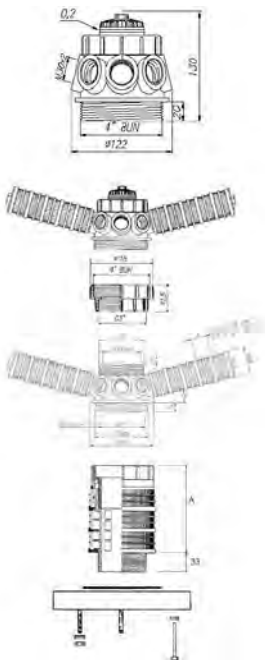

Ref	Description	Fam.	Subfam.	Disp. Stock	
PV534	LOWER LATERAL SYSTEM FLANG. 6" DN80 PRES.VES.42"SLOTS 0,2 MM*	45	201	OK	
PV535	LOWER LATERAL SYSTEM FLANG. 6" DN80 PRES. VES. 48" DIFF. 0,2 MM*	45	201	OK	
PV536	LOWER LATERAL SYSTEM FLANG. 6" DN80 PRES.VES.42"SLOTS 0,5 MM*	45	201	OK	
PV537	LOWER LATERAL SYSTEM FLANG. 6" DN80 PRES.VES.48"SLOTS 0,5 MM*	45	201	OK	

Ref	Lateral quantity	A (mm)	Slots (mm)	Flow (m3/h) Δp 0,2 bar	Diffusor lenght (mm)	Ø Systems (mm)
PV534	8 + 8	150	0,2	38	361-423	819-939
PV535	8 + 8	150	0,2	38	423-485	939-1059
PV536	8 + 8	150	0,5	38	361-423	819-939
PV537	8 + 8	150	0,5	38	423-485	939-1059

Certificates	Manufacturer	Sectors
		Industrial



## Pressure Vessels Accessories

### Top mount lower lateral systems for flanged pressure vessels



- Lower lateral system for 6" flanged pressure vessels for top mount valve, with 6 laterals;
- Material hub and laterals PP, length as table below;
- Slots 0,2 or 0,5 mm;
- To install with 2" adapter for the needed riser tube diameter.

Ref	Description	Fam.	Subfam.	Disp. Stock	
PV540	LOWER LATERAL SYSTEM TOP MOUNT PRES.VES. 18"-21" SLOTS 0,2 MM*	45	201	OK	
PV544	LOWER LATERAL SYSTEM TOP MOUNT PRES.VES. 18"-21" SLOTS 0,5 MM*	45	201	OK	

Ref	Ø Vessel	Diffusor length (mm)	Ø Diameter (mm)	Slots (mm)	Flow (m³/h) Δp 0,2 bar
PV540	18" - 21"	144	374	0,2	22
PV544	18" - 21"	144	374	0,5	22

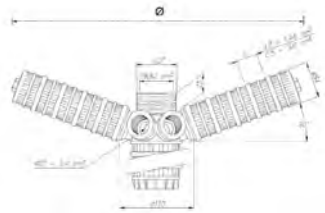

Ref	Description	Fam.	Subfam.	Disp. Stock	
PV541	LOWER LATERAL SYSTEM TOP MOUNT PRES.VES. 24" SLOTS 0,2 MM*	45	201	OK	
PV545	LOWER LATERAL SYSTEM TOP MOUNT PRES.VES. 24" DIFF. 0,5 MM*	45	201	OK	

Ref	Vessel	Diffusor length (mm)	Ø Diameter (mm)	Slots (mm)	Flow (m³/h) Δp 0,2 bar
PV541	24"	175	432	0,2	23
PV545	24"	175	432	0,5	23

Certificates	Manufacturer	Sectors
		Industrial



## Pressure Vessels Accessories



Ref	Description	Fam.	Subfam.	Disp. Stock	
PV542	LOWER LATERAL SYSTEM TOP MOUNT PRES.VES. 30" SLOTS 0,2 MM*	45	201	OK	
PV546	LOWER LATERAL SYSTEM TOP MOUNT PRES.VES. 30" SLOTS 0,5 MM*	45	201	OK	

Ref	Ø Vessel	Diffusor lenght (mm)	Ø Diameter (mm)	Slots (mm)	Flow (m³/h) Δp 0,2 bar
PV542	30"	237	549	0,2	24
PV546	30"	237	549	0,5	24

Certificates	Manufacturer	Sectors
		Industrial

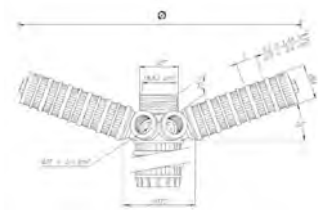

Ref	Description	Fam.	Subfam.	Disp. Stock	
PV543	LOWER LATERAL SYSTEM TOP MOUNT PRES.VES. 36" SLOTS 0,2 MM*	45	201	OK	
PV547	LOWER LATERAL SYSTEM TOP MOUNT PRES.VES. 36" SLOTS 0,5 MM*	45	201	OK	

Ref	Ø Vessel	Diffusor lenght (mm)	Ø Diameter (mm)	Slots (mm)	Flow (m³/h) Δp 0,2 bar
PV543	36"	299	665	0,2	25
PV547	36"	299	665	0,5	25

Certificates	Manufacturer	Sectors
		Industrial

### 2" gas adapter

- 2" GAS adapters with connection to glue;
- Material PVC.

Ref	Description	Fam.	Subfam.	Disp. Stock	
PV384	ADAPTER F/F 2"x41,8 MM TO GLUE	45	201	OK	
PV385	ADAPTER F/F 2"x48,3 MM TO GLUE	45	201	OK	
PV386	ADAPTER F/F 2"x50 MM TO GLUE	45	201	OK	
PV387	ADAPTER F/F 2"x63 MM TO GLUE	45	201	OK	

Ref	Description	Connection to glue (mm)
PV384	ADAPTER F/F 2"x41,8 MM TO GLUE	41,8
PV385	ADAPTER F/F 2"x48,3 MM TO GLUE	48,3
PV386	ADAPTER F/F 2"x50 MM TO GLUE	50,0
PV387	ADAPTER F/F 2"x63 MM TO GLUE	63,0

Certificates	Manufacturer	Sectors
		Industrial



## Pressure Vessels Accessories

### Top mount lower lateral systems for tubes diameter 90 mm

- Lower lateral system for 6" flanged pressure vessels for top mount valve, with 8 laterals;
- Material hub and laterals PP, length as table below;
- Slots 0,2;
- To glue on tube diameter 90 mm.

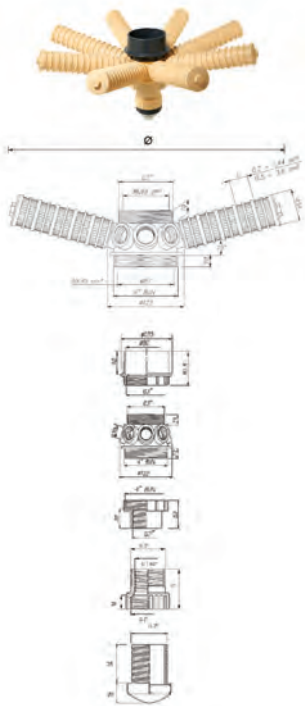

Ref	Description	Fam.	Subfam.	Disp. Stock	
PV548	LOWER LATERAL SYSTEM TOP MOUNT PRES.VES. 30" FORTUBE 90 MM SLOTS 0,2 MM*	45	201	OK	
PV549	LOWER LATERAL SYSTEM TOP MOUNT PRES.VES. 36" TUBE90 MM SLOTS 0,2 MM*	45	201	OK	

Ref	Diffusor lenght (mm)	Ø Diameter	Slots (mm)	Flow (m³/h) Δp 0,2 bar
PV548	237	580	0,2	36
PV549	299	699	0,2	38

Certificates	Manufacturer	Sectors
		Industrial

### Top mount lower double lateral systems for tubes diameter 90 mm

- Lower lateral system for 6" flanged pressure vessels for top mount valve, with 8+8 laterals;
- Material hub and laterals PP, length as table below;
- Slots 0,2;
- To glue on tube diameter 90 mm.

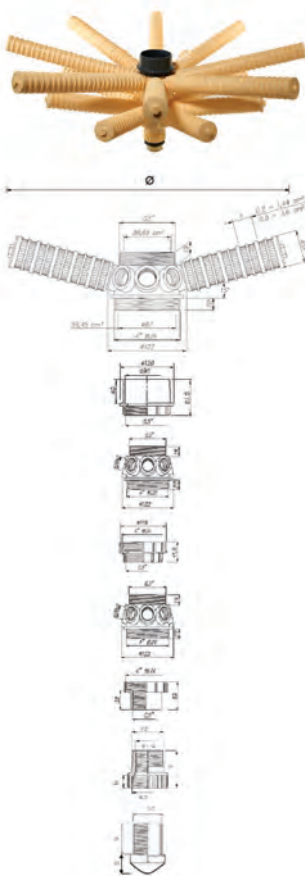

Ref	Description	Fam.	Subfam.	Disp. Stock	
PV550	LOWER LATERAL SYSTEM TOP MOUNT PRES.VES. 42" FORTUBE 90 MM SLOTS 0,2 MM*	45	201	OK	
PV551	LOWER LATERAL SYSTEM TOP MOUNT PRES.VES. 48" TUBE90 MM SLOTS 0,2 MM*	45	201	OK	

Ref	Laterals quantity	Lateral lenght (mm)	Ø Diameter (mm)	Slots(mm)	Flow (m³/h) Δp 0,2 bar
PV550	8 + 8	299-423	699-939	0,2	38
PV551	8 + 8	361-485	819-1059	0,2	38

Box: WxLxH	Box: Q.ty	Box: Weight	Pallet: WxLxH	Pallet: Q.ty	Pallet: Weight

Certificates	Manufacturer	Sectors
		Industrial



## Pressure Vessels Accessories

### Cylindrical laterals

- Cylindrical laterals with threaded connection M 30x2;
- Material PP;
- Diameter 54 mm;
- Slots 0,2 or 0,5 mm.

### Laterals with 0,2 mm slots



Ref	Description	Fam.	Subfam.	Disp. Stock	
PV345	LATERAL DIFFUSER M 30 X 2 L=113 - 0,2 MM	45	201	OK	
PV370	LATERAL DIFFUSER M 30X2 L=144 - 0,2 MM	45	201	OK	
PV346	LATERAL DIFFUSER M 30 X 2 L=175 - 0,2 MM	45	201	OK	
PV371	LATERAL DIFFUSER M 30X2 L=206 - 0,2 MM	45	201	OK	
PV347	LATERAL DIFFUSER M 30 X 2 L=237 - 0,2 MM	45	201	OK	
PV348	LATERAL DIFFUSER M 30 X 2 L=299 - 0,2 MM	45	201	OK	
PV372	LATERAL DIFFUSER M 30X2 L=361 - 0,2 MM	45	201	OK	
PV373	LATERAL DIFFUSER M 30X2 L=423 - 0,2 MM	45	201	OK	
PV374	LATERAL DIFFUSER M 30X2 L=485 - 0,2MM	45	201	OK	
PV389	LATERAL DIFFUSER M 30X2 L=578 - 0,2 MM	45	201	OK	
PV391	LATERAL DIFFUSER M30x2 L = 640 MM SLOTS 0,2 MM	45	201	OK	

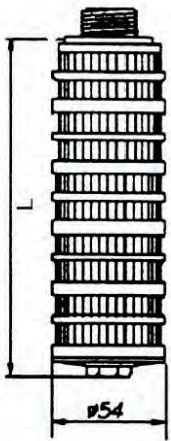

Ref	Description	L (mm)
PV345	LATERAL DIFFUSER M 30 X 2 L=113 - 0,2 MM	113
PV370	LATERAL DIFFUSER M 30X2 L=144 - 0,2 MM	144
PV346	LATERAL DIFFUSER M 30 X 2 L=175 - 0,2 MM	175
PV371	LATERAL DIFFUSER M 30X2 L=206 - 0,2 MM	206
PV347	LATERAL DIFFUSER M 30 X 2 L=237 - 0,2 MM	237
PV348	LATERAL DIFFUSER M 30 X 2 L=299 - 0,2 MM	299
PV372	LATERAL DIFFUSER M 30X2 L=361 - 0,2 MM	361
PV373	LATERAL DIFFUSER M 30X2 L=423 - 0,2 MM	423
PV374	LATERAL DIFFUSER M 30X2 L=485 - 0,2MM	485
PV389	LATERAL DIFFUSER M 30X2 L=578 - 0,2 MM	578
PV391	LATERAL DIFFUSER M30x2 L = 640 MM SLOTS 0,2 MM	640

Certificates	Manufacturer	Sectors
		Industrial



### Cylindrical laterals

- Cylindrical laterals with threaded connection M 30x2;
- Material PP;
- Diameter 54 mm;
- Slots 0,2 or 0,5 mm.

### Laterals with 0,5 mm slots

Ref	Description	Fam.	Subfam.	Disp. Stock	
PV375	LATERAL DIFFUSER M 30X2 L=113 - 0,5 MM	45	201	OK	
PV376	LATERAL DIFFUSER M 30X2 L=144 - 0,5 MM	45	201	OK	
PV377	LATERAL DIFFUSER M 30X2 L=175 - 0,5 MM	45	201	OK	
PV378	LATERAL DIFFUSER M 30X2 L=206 - 0,5 MM	45	201	OK	
PV379	LATERAL DIFFUSER M 30X2 L=237 - 0,5 MM	45	201	OK	
PV380	LATERAL DIFFUSER M 30X2 L=299 - 0,5 MM	45	201	OK	
PV381	LATERAL DIFFUSER M 30X2 L=361 - 0,5 MM	45	201	OK	
PV382	LATERAL DIFFUSER M 30X2 L=423 - 0,5 MM	45	201	OK	
PV383	LATERAL DIFFUSER M 30X2 L=485 - 0,5 MM	45	201	OK	
PV390	LATERAL DIFFUSER M30x2 L = 578 - 0,5 MM	45	201	OK	
PV392	LATERAL DIFFUSER M 30X2 L=640 - 0,5 MM	45	201	OK	

Ref	Description	L (mm)
PV375	LATERAL DIFFUSER M 30X2 L=113 - 0,5 MM	113
PV376	LATERAL DIFFUSER M 30X2 L=144 - 0,5 MM	144
PV377	LATERAL DIFFUSER M 30X2 L=175 - 0,5 MM	175
PV378	LATERAL DIFFUSER M 30X2 L=206 - 0,5 MM	206
PV379	LATERAL DIFFUSER M 30X2 L=237 - 0,5 MM	237
PV380	LATERAL DIFFUSER M 30X2 L=299 - 0,5 MM	299
PV381	LATERAL DIFFUSER M 30X2 L=361 - 0,5 MM	361
PV382	LATERAL DIFFUSER M 30X2 L=423 - 0,5 MM	423
PV383	LATERAL DIFFUSER M 30X2 L=485 - 0,5 MM	485
PV390	LATERAL DIFFUSER M30x2 L = 578 - 0,5 MM	578
PV392	LATERAL DIFFUSER M 30X2 L=640 - 0,5 MM	640

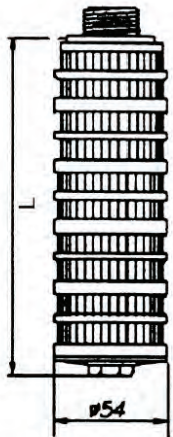

Certificates	Manufacturer	Sectors
		Industrial



## Pressure Vessels Accessories

### Flange coupling kit



- For 6" flanged pressure vessels;
- Including flange adaptor and coupling flange in PVC;
- With gasket in EPDM.

Ref	Description	Fam.	Subfam.	Disp. Stock	
PV594M	FLANGE COUPLING KIT DN65-D75-2"1/2*	45	210	OK	
PV595M	FLANGE COUPLING KIT DN80-D90-3"*	45	210	OK	
PV596M	FLANGE COUPLING KIT DN100-D110-4"*	45	210	OK	

Ref	Description	Connection
PV594M	FLANGE COUPLING KIT DN65-D75-2"1/2*	DN65
PV595M	FLANGE COUPLING KIT DN80-D90-3"*	DN80
PV596M	FLANGE COUPLING KIT DN100-D110-4"*	DN100

Certificates	Manufacturer	Sectors
		Industrial

PV295



### Mineral tank funnels

- The tank funnels are designed for filling mineral tanks with granular media and ion exchange resin;
- The funnels are designed to fit 2,5", 4" and 6" mineral tank openings;
- These economical funnels are nestable to reduce shipping and storage costs;
- The funnel ref. PV395 snaps into a 4" or 6" mineral tank opening for stability when pouring media. The neck of the funnel has been carefully designed to allow trapped air inside the mineral tank to escape when media is poured in. This heavy duty part is blow molded out of high density polyethylene for exceptional strength and durability. The oval design provides an extra wide opening for ease of use when pouring. Handles are molded into the funnel for added convenience.

Ref	Description	Fam.	Subfam.	Disp. Stock	
PV295	MINERAL TANK FUNNEL 2.5"	45	196	OK	
PV395	MINERAL TANK FUNNEL 4" - 6"	45	201	OK	

PV395



Certificates	Manufacturer	Sectors
		Domestic, Commercial, Industrial





## Pressure Vessels Accessories

### Jackets with zip for Pressure Tanks

- In Neoprene insulating material;
- Standard black colour;
- On demand and for minimum order quantities we can supply customized colours.



Ref.	Description	Fam.	Subfam.	Disp. Stock	
BMWGJD0613	MWG BLACK JACKET 6X13	43	198	NO	
BMWGJD0813	MWG BLACK JACKET 8X13	43	198	NO	
BMWGJD0817	MWG BLACK JACKET 8X17	43	198	NO	
BMWGJD0844	MWG BLACK JACKET 8X44	43	198	NO	
BMWGJD0948	MWG BLACK JACKET 9X48	43	198	NO	
BMWGJD1019	MWG BLACK JACKET 10X19	43	198	NO	
BMWGJD1035	MWG BLACK JACKET 10X35	43	198	OK	
BMWGJD1044	MWG BLACK JACKET 10X44	43	198	OK	
BMWGJD1054	MWG BLACK JACKET 10X54	43	198	OK	
BMWGJD1248	MWG BLACK JACKET 12X48	43	198	NO	
BMWGJD1252	MWG BLACK JACKET 12X52	43	198	NO	
BMWGJD1344	MWG BLACK JACKET 13X44	43	198	NO	
BMWGJD1354	MWG BLACK JACKET 13X54	43	198	NO	
BMWGJD1452G	MWG BLACK JACKET 14X52	44	198	NO	
BMWGJD1465G	MWG BLACK JACKET 14X65 4	44	198	NO	
BMWGJD1465H	MWG BLACK JACKET 14X65 4-4	44	198	NO	
BMWGJD1665H	MWG BLACK JACKET 16X65 4-4	44	198	NO	
BMWGJD1865H	MWG BLACK JACKET 18X65 4-4	44	198	NO	
BMWGJD2162H	MWG BLACK JACKET 21X62 4-4	44	198	NO	
BMWGJD2472H	MWG BLACK JACKET 24X72 4-4	44	198	NO	
BMWGJD3072H	MWG BLACK JACKET 30X72 4-4	44	198	NO	
BMWGJD3672H	MWG BLACK JACKET 36X72 4-4	44	198	NO	

Certificates	Manufacturer	Sectors
	<b>MWG</b>	Domestic, Commercial, Industrial